

GLOBO

LIGHTING

www.globo-lighting.com

41341-12

<https://youtu.be/PcogAAycb2U>

B

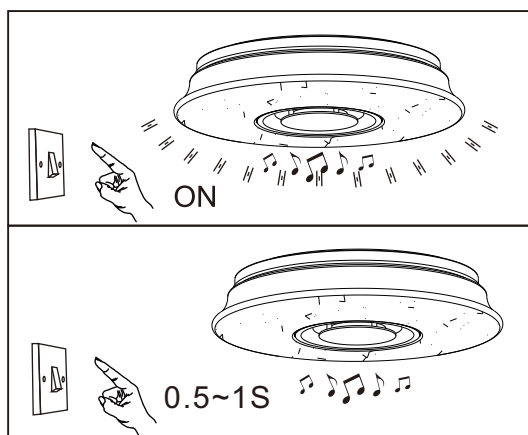
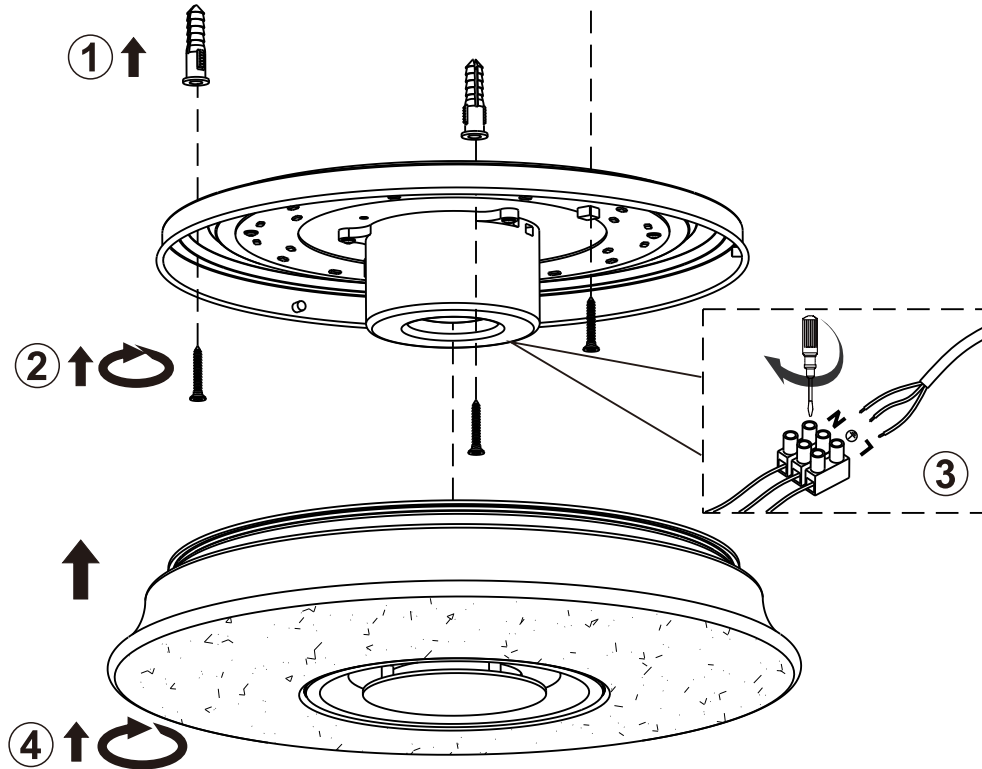
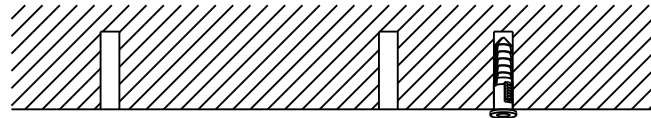

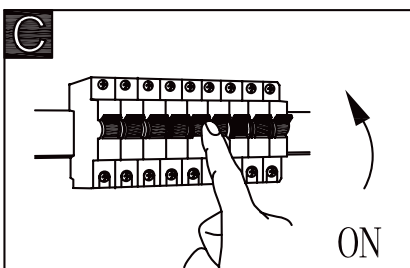
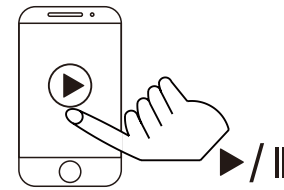
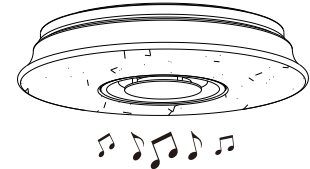
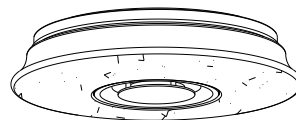

Bluetooth
GLOBO 41341-12



GLOBO Handels GmbH
Gewerbestr. 3
A-9184 Sankt Peter

DE

Lichtquelle:
Die Lichtquelle ist nicht tauschbar, weil sie konstruktionsbedingt fest mit dem umgebenden Produkt verbunden ist.
Dieses Produkt enthält eine Lichtquelle der Energieeffizienzklasse G.

   Leuchtmittel nicht austauschbar.

EN

Light source:
The light source is not interchangeable because it is determined by the surrounding product design.
This product contains a light source of energy efficiency class G.

   Non replaceable light source.

BIH & HR

Izvor svjetla :
Izvor svjetla nije zamjenjiv, jer je konstrukcijski pričvršćen na proizvod.
Ovaj proizvod sadržava izvor svjetlosti klase energetske učinkovitosti G.

   LED žarulje nije moguće zamjeniti.



BG

Източник на светлина:
Източникът на светлина не може да се подменя, тъй като поради конструкцията си е трайно фиксиран към заобикалящия го продукт.
Този продукт включва светлинен източник с клас на енергийна ефективност G.

   Източникът на светлина не може да се подменя.



CZ

Zdroj světla:
Světelný zdroj není možné vyměnit, protože je díky své konstrukci pevně spojený s produktem.
Tento výrobek obsahuje světelný zdroj s třídou energetické účinnosti G.

   Světelný zdroj není vyměnitelný.



DK

Lyskilde:
Lyskilden kan ikke udskiftes, fordi den er fast forbundet med det omgivende produkt.
Dette produkt indeholder en lyskilde i energieffektivitetsklasse G.

   Lyskilden kan ikke udskiftes.

ET

Valgusallikas:
Valgusallikas ei ole välja vahetatav, sest ta on tootega ehituslikult kindlalt seotud.
Toode sisaldab energiatõhususe klassi G valgusallikat.

   Lamp ei ole välja vahetatav.



ES

Fuente de luz:
La fuente de luz no es sustituible porque está fija en el producto desde la construcción.
Este producto contiene una fuente luminosa de la clase de eficiencia energética G.

   Bombilla no reemplazable.

FI

Valonlähde:
Valonlähdettä ei voi vaihtaa uuteen, sillä se on rakenteellisesti yhdistetty ympäröivään tuotteeseen.
Tämä tuote sisältää valonlähteen, jonka energiatehokkuusluokka on G.

   Valonlähdettä ei voi vaihtaa.



FR

Source lumineuse:
La source lumineuse n'est pas remplaçable car elle est, de par la construction du produit, liée de façon permanente à celui-ci.
Ce produit contient une source lumineuse de classe d'efficacité énergétique G.

   Ampoule non remplaçable.

GR

Φωτεινή πηγή:
Η φωτεινή πηγή δεν μπορεί να αντικατασταθεί, επειδή είναι για κατασκευαστικούς λόγους σταθερά συνδεδεμένη με το προϊόν που την περιβάλλει.
Το προϊόν αυτό περιέχει φωτεινή πηγή της τάξης ενεργειακής απόδοσης G.

   Ο λαμπτήρας δεν μπορεί να αντικατασταθεί.

HU

Fényforrás:
A fényforrás nem cserélhető, mert felépítése miatt szilárdan csatlakozik a termékhez.
Ez a termék egy G energiatékonysági osztályú fényforrást tartalmaz.

   A fényforrás nem cserélhető.

IS

Ljósgefafi:
Ljósgefaffinn er ekki útskiptanlegur vegna þess að hann er háður umliggjandi hönnun vörunnar.
Varan inniheldur ljósgefafa í orkuflokki G.

   Ekki útskiptanlegur ljósgefafi.

IT

Sorgente luminosa:
La sorgente luminosa non è intercambiabile perché è saldamente collegata al prodotto per via del suo design.
Questo prodotto contiene una sorgente luminosa di classe di efficienza energetica G.

   Lampadine non intercambiabili.



LV

Gaismas avots:
Gaismas avotu nevar nomainīt, jo tas konstrukcijā ir cieši savienots ar izstrādājuma apkārtējo daļu.
Šis ražojums satur gaismas avotu, kura energoefektivitātes klase ir G.

   Apgaismes līdzekli nevar nomainīt.



LT

Šviesos šaltinis:
Šis šviesos šaltinis yra nekeičiamas, nes jis prijungtas prie gaminio pagal jo konstrukciją.
Šiame gaminyje yra šviesos šaltinis, kurio energijos vartojimo efektyvumo klasė G.

   Šviesos šaltinis yra nekeičiamas.

NL

Lichtbron:
De lichtbron kan niet worden vervangen, omdat deze vanwege de constructie vast met het product eromheen verbonden is.
Dit product bevat een lichtbron van energie-efficiëntieklasse G.

   Verlichting kan niet worden vervangen.



NO

Lyskilde:
Lyskilden kan ikke byttes fordi den sitter fast i produktet.
Dette produktet inneholder en lyskilde i energiklasse G.

   Lyskilden kan ikke byttes ut.



PL

Źródło światła:
Źródła światła nie można wymienić, ponieważ jest zintegrowane z produktem ze względu na swoją konstrukcję.
Ten produkt zawiera źródło światła o klasie efektywności energetycznej G.

   Źródła światła nie można wymienić.

PT

Fonte de Luz:
A fonte de luz não é substituível porque devido às suas características construtivas está fixada de forma permanente ao produto circundante.
Este produto contém uma fonte de luz da classe de eficiência energética G.

   Lâmpada não substituível.



RO

Sursa de lumina:
Sursa de lumina nu este inlocuibilă ea fiind parte constructivă a produsului.
Acest produs conține o sursă de lumină cu clasa de eficiență energetică G.

   Sursa de lumina nu poate fi schimbata.

RUS

Источник света:
Источник света не является взаимозаменяемым, поскольку это определяется конструкцией данного продукта.
Данный продукт содержит источник света класса энергоэффективности G.

  Незаменяемый источник света.



SRB

Izvor svetlosti:
Izvor svetlosti nije zamenljiv, jer je zbog svog dizajna čvrsto povezan sa proizvodom koji ga okružuje.
Ovaj proizvod sadrži izvor svetlosti klase energetske efikasnosti G.

   Izvor svetlosti se ne može zameniti.



SK

Zdroj svetla:
Světelný zdroj nie je možné vymeniť, pretože je vďaka svojej konštrukcii pevne spojený s produktom.
Tento výrobok obsahuje svetelný zdroj triedy energetickej účinnosti G.

   Svetelný zdroj nie je vymeniteľný.



SI

Izvor svetlobe:
Vir svetlobe ni zamenljiv, ker je določen z zasnovno izdelka v okolici.
Ta izdelek vsebuje svetlobni vir razreda energijske učinkovitosti G.

   Nezamenljiv vir svetlobe.



SE

Ljuskälla:
Ljuskällan är inte utbytbar, eftersom den på grund av konstruktionen är fast integrerad i den omgivande produkten.
Denna produkt innehåller en ljuskälla med energieffektivitetsklass G.

   Ljuskällan är inte utbytbar.

TR

Işık kaynağı:
Konstrüksiyon gereği çevreleyen ürün ile sabit bir şekilde bağlı olduğu için ışık kaynağı değiştirilemez.
Bu ürün, G enerjisi sınıfından bir ışık kaynağına sahiptir.

   Ljuskällan är inte utbytbar.

UK

Джерело світла:
Джерело світла не можна обміняти, оскільки воно міцно пов'язане з навколишнім виробом завдяки своїй конструкції.
Цей виріб містить джерело світла класу енергоефективності G.

   Цибулини не взаємозамінні.